



TRUCK
HIGHEST PERFORMANCE FOR
COMFORT AND EFFICIENCY

BUILDING TRUST



SIKA TRANSPORTATION AT A GLANCE

150,000 TRUCKS

PRODUCED EVERY YEAR
CONTAIN SIKA PRODUCTS

QUIETER TRUCK CABINS:

**25 %
NOISE REDUCTION**

WITH SikaBaffle® AND SikaDamp®
ACOUSTIC SYSTEMS

LIGHTER TRUCK DESIGN:

**80 KG
WEIGHT
REDUCTION**

WITH Sikaflex® LOW DENSITY
ADHESIVES AND SEALANTS

**250,000
TRUCK CABINS**

PRODUCED WITH SIKA SOLUTIONS
ANNUALLY

**22 MILLION KG
SIKA PRODUCTS**

PURCHASED BY THE TRANSPORTATION
MARKET EVERY YEAR

For decades Sika has been supporting its customers in the global transportation industry. This dynamic and challenging environment demands that owners and operators achieve not only ever lower vehicle running and repair costs, but also improved reliability and durability. Additionally, government legislations demand lower vehicle emissions and the use of safer process materials as well as improved passenger and driver safety. As a major supplier and partner to the global transportation industry, Sika is committed to providing a vast range of state-of-the-art solutions to assist manufacturers in meeting these challenges.

CONTENT

04	Truck Trends	
06	Truck Applications	
08	Body and Paint Shop	layar
10	Noise, Vibration and Harshness Systems	layar
12	Direct Glazing	layar
14	High Roof and Exterior Parts Bonding	layar
16	Interior Trim	layar
18	Service and Support	
19	Sika Industry Brands	

AUGMENTED REALITY

We'd like to show you animations of the truck-applications.
You can experience the animations live on your mobile device.

For doing so, please follow the instructions below for iOS or Android.



1. Download the free app «Layar» on the App-Store.
2. Open the app and scan the exploded views marked with the «Layar» logo.
3. Enjoy the animations.

TRUCK TRENDS

LIGHTER, STRONGER, FASTER, SAFER

The global truck industry is a dynamic and challenging environment. Truck operators demand ever-lower vehicle operating and repair costs combined with improved reliability and durability. Government legislation is regulating lower vehicle emissions and improved safety.



LIGHTWEIGHT DESIGN



Modern vehicles must comply with ever increasing legislative requirements for reduced emissions. At the same time, more and more electronic driving aid systems must be incorporated into trucks to ensure increased driving safety. Furthermore, fleet operators demand the lowest possible operating cost. These combined requisites have given truck manufacturers the daunting task of producing lighter vehicles with lower fuel consumption. Sika offers technologies which help to reduce vehicle weight substantially by the use of lighter and dissimilar substrates

IMPROVED CRASH PERFORMANCE



New regulations and broad implementation of more stringent crash standards strongly impact the transport industry. This is a challenge for truck manufacturers since the required crash tests and redesign of vehicles in order to comply with these tough regulations can be quite costly. Sika offers custom-made solutions which are easy to implement and require limited or even no re-design of the truck body.





FASTER PROCESSES



In a fierce market environment, quality plays a key role. However, costs are of equal importance to truck manufacturers in order to maintain competitiveness and success. Therefore, focus is put on process simplification in order to reduce the risk of mistakes and on shorter cycle times to increase capacity and remove bottlenecks. Sika provides advice and solutions on how to achieve these goals with our accelerated and two-component systems - simple products which require neither heat for curing nor a lot of pretreatments.

ENVIRONMENTAL HEALTH AND SAFETY



The global chemical industry is constantly evolving with technology playing a greater role helping companies ensure compliance, drive profitability, reduce risks, and improve environmental and social performance. At the same time new legislation, harsher classification, and higher demands on worker safety are problematic for everyone involved with chemical substances. Sika is dedicated to sustainable development and provides innovative solutions like water-based pretreatments, phthalate- and tin-free sealants and adhesives, as well as products which allow for reduced consumption and considerable weight saving.



TRUCK APPLICATIONS

Manufacturer as well as truck operator require and demand reliability and durability in combination with continuous reduction of vehicle production and operating cost. Sika, as supplier and partner to the global truck industry, provides a range of state of the art technology solutions to assist truck manufacturers in meeting these challenges. As a specialty company for chemical products, we concentrate on our core competencies: Bonding, Sealing, Damping and Reinforcing.

NOISE, VIBRATION AND HARSHNESS SYSTEMS

Proven technologies supply best in class performance. >> **Page 10**

BODY AND PAINT SHOP

Sealing and bonding products based on different technologies meet all process needs. >> **Page 8**

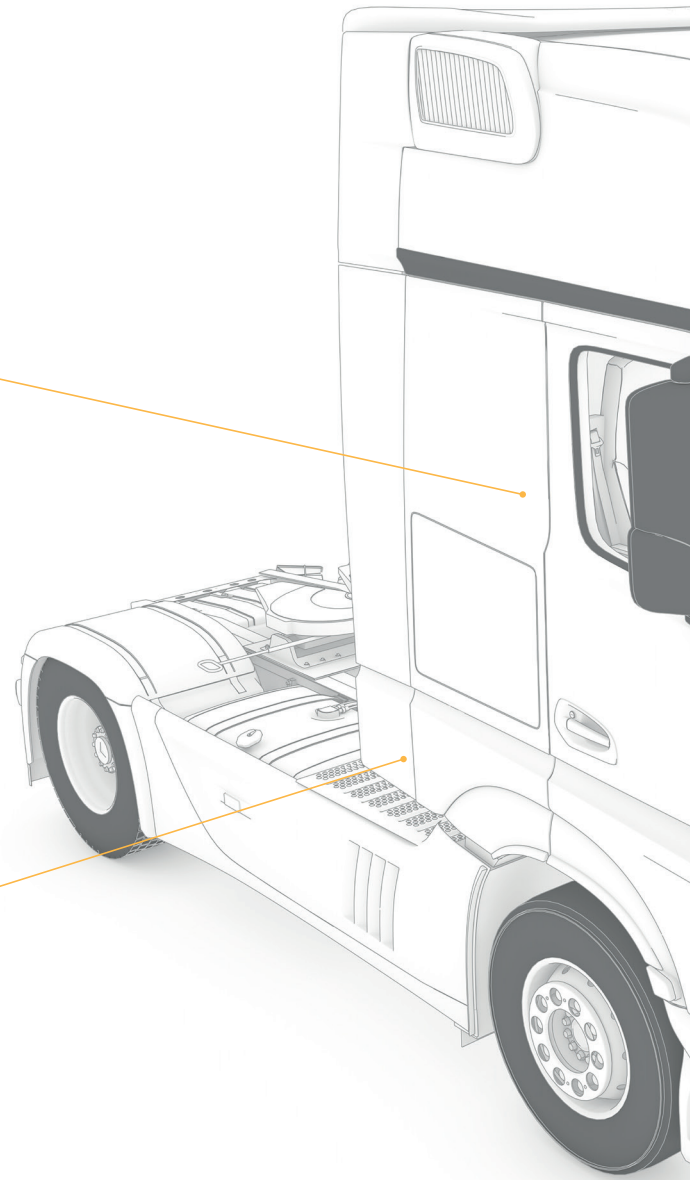



HIGH ROOF AND EXTERIOR PARTS BONDING

Structural and flexible solution for Composites or plastic parts. >> **Page 14**

DIRECT GLAZING

A large portfolio of direct glazing adhesives is available to meet all process needs, may it be high non-slip down performance, fast-curing speed or process simplification thanks to black-primerless solutions. >> **Page 12**

INTERIOR TRIM

Large variety of technologies offering fast assembly and high initial tack to ensure no interruption of the manufacturing process. >> **Page 16**

BODY AND PAINT SHOP

Truck manufacturers use a wide range of materials and processes in the assembly of the 'body in white' structure within the body shop.

To save weight, dissimilar material will get more and more common and cost reduction is asking for low temperature solutions. Sika provides a range of material technologies ideally suited to this challenging environment.

SikaPower® structural adhesives and sealants are easy to combine with other joining technologies. Flexibility, durability and a reduction in the number of spot welding points are just some of the advantages provided by these products.

Sikaflex® sealing solutions are easy to use one-component, humidity curing formulations which provide excellent tooling properties and help substantially reduce the risk of corrosion, water ingress and standing water.



“OEM are driving the need for durable body shop adhesives which improve stiffness, crash resistance and fatigue performance and are contributing significantly to reduce overall weight. Sika provides a broad range of high performance solutions.”

BENEFITS

- Adhesion to oiled metals without pre-treatment or degreasing
- Excellent ageing and long-term durability
- Superb wash out resistance
- Low bake curing to improve object temperature variations
- Solvent and PVC free
- Manual or automatic application options

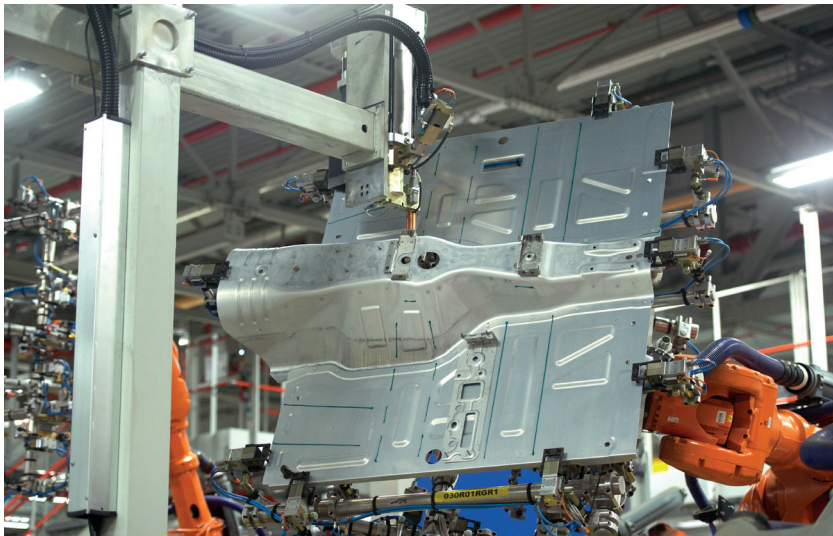

PRODUCTS	PRODUCT DESCRIPTION
Sikaflex®-215	Low viscous, brushable seam sealant with outstanding application properties
SikaSeal®-710 LS	Antiflutter sealant with optimized bond-line read through resistance
SikaPower®-415 P1	Moisture pre-curable, heat curing body shop sealant
SikaPower®-480	Structural metal adhesive for spot weld bonding
SikaPower®-487	Crash resistant, low temperature curing metal adhesive
SikaPower®-492	Semi crash resistant structural metal adhesive
SikaPower®-497	Crash resistant metal adhesive - cold pumpable
SikaPower®-498/3	Crash resistant metal adhesive - warm pumpable

NOISE, VIBRATION AND HARSHNESS SYSTEMS

Truck operators and government bodies are demanding ever lower standards of interior and exterior vehicle noise. Sika has formulated technology solutions to facilitate significant reductions in vehicle noise by absorption of vibration within the vehicle body.

SikaBaffle® solutions use lightweight, preshaped, molded, extruded and die-cut parts within the primary body structure to effectively block common noise transmission paths. SikaBaffle® product families include thermoplastic and elastomeric-based formulations. They are designed to be heat activated and expanded inside vehicle body cavities.

SikaReinforcer® technologies use lightweight, pre-shaped, injection molded parts within the primary body structure sections to effectively control the dynamic or static stiffness in torsion or bending of the vehicle body, without adding significant mass.

Sikagard® spray on technology is a unique, spray applied damping and protecting solution designed to minimize interior noise. It exhibit excellent sound deadening and stone chip resistance together with outstanding workability characteristics.



Comfortable rides with improved driving capabilities and body stiffness. Vehicle manufacturers make use of Sika's vast experience in this field to produce best in class trucks solution."

BENEFITS

- Lightweight solutions that allow for a complete sealing of cavities
- Superior acoustic performance
- Prevents noise, water, moisture and dust from entering the vehicle
- Improves overall vehicle stiffness
- Weight reduction vs equivalent steel solution
- Flexible design possibilities
- Simple assembly process - simplified joining method

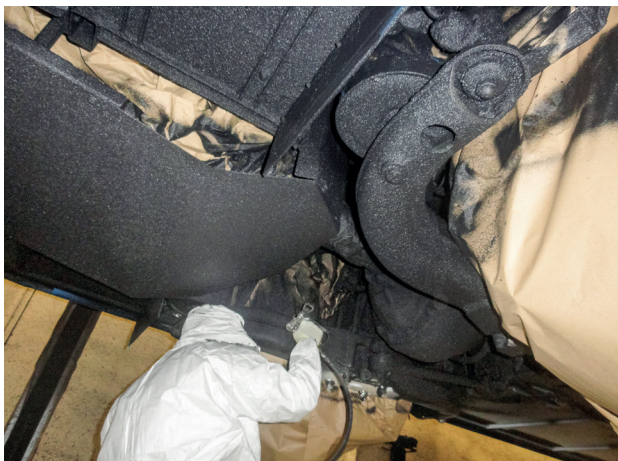

PRODUCTS	PRODUCT DESCRIPTION
SikaBaffle®-45x	High expanding, thermoplastic, injection molded / profile extruded cavity sealer
SikaBaffle®-2xx	Co-extruded, rubber-based, expandable sealant for sealing and acoustic treatment
SikaReinforcer®-94x	High performance, injection molded and heat expandable reinforcing system
Sikagard®-6682	Sprayable waterborne sound deadening & anti chip coating

DIRECT GLAZING

For over 30 years, Sika has been providing Truck assembly lines with adhesives and sealants for direct glazing applications. The solutions vary from standard products to innovative systems with high initial strength and accelerated curing speed. Sika offers a wide range of adhesive to suit various needs for direct glazing applications.

Sikaflex® materials are capable of retaining the glass in position following installation, allowing for elimination of secondary clips, fixings and tape. Our products can also provide low electrically conductive properties for elimination of galvanic corrosion/antenna signal loss. The Sikaflex®

Booster and PowerCure range offers ultimate solutions for OEM's seeking excellent mechanical properties with the shortest possible full cure time and provides the opportunity to have the same system accelerated from line application to repair.

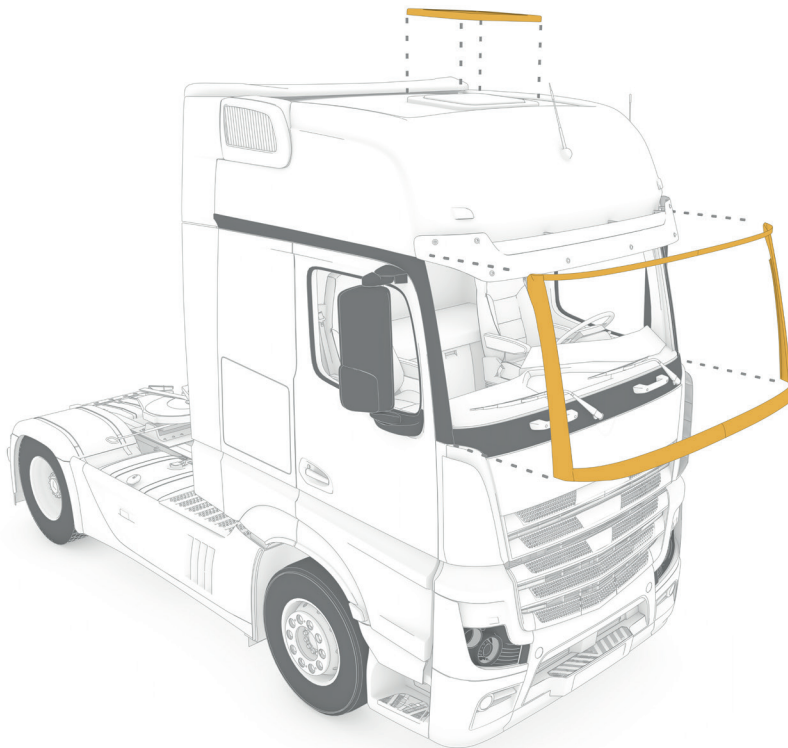

“Significant cost reduction and simplification of production processes can be achieved through the use of Sika adhesives. Manual or automated pre-treatment without the use of black primer is possible.”

BENEFITS

- Improved body stiffness for enhanced roll over strength and improved occupant impact protection
- Enhanced aerodynamics compared with gasket glazed systems to improve fuel economy and vehicle emissions
- Excellent protection against water and moisture ingress
- Improved sound and vibration damping
- Compatible with automated and robot guided applications



PRODUCTS	PRODUCT DESCRIPTION
Sikaflex®-263	Direct glazing adhesive with good weathering stability
Sikaflex®-268 System	All in one adhesive/sealant system with very good ageing and weathering resistance and accelerated sealing capability
Sikaflex®-265 DG-1	Very good non slip down performance
Sikaflex®-271 + SikaBooster®-20W	Fast-curing direct glazing adhesive system for line operations and small accelerated applications and repair
Sikaflex®-271 PowerCure	
SikaTack® Move Transportation	Direct glazing adhesive for repair

HIGH ROOF AND EXTERIOR PARTS BONDING

Truck designers and manufacturers increasingly use thermoplastic and thermoset composite materials to construct exterior components. Improved interior space, lower noise, greater insulation and increased interior stowage space have facilitated development of high roof sleeper cab trucks capable of providing maximum comfort for protracted journeys. Sika provides a complete range of specific structural adhesives to fulfill highest demands in terms of quality, performance and service.

Sikaflex® provides high performance elastic assembly within an easy to use one component formulation. Sikaflex® can also be combined with Sika's proprietary SikaBooster® and PowerCure® technologies to provide rapid full cure for applications requiring fast assembly speeds.

SikaFast® Acrylic adhesives are two-part adhesives that provide excellent bond strength and durability.

SikaPower® Epoxy adhesives come in two-part adhesives and cure upon mixing the two components. They generally have the highest strength and overall performance.

SikaForce® two component Polyurethane adhesives are relatively flexible when cured, and therefore tend to have excellent impact resistance and good adhesion to most plastics.

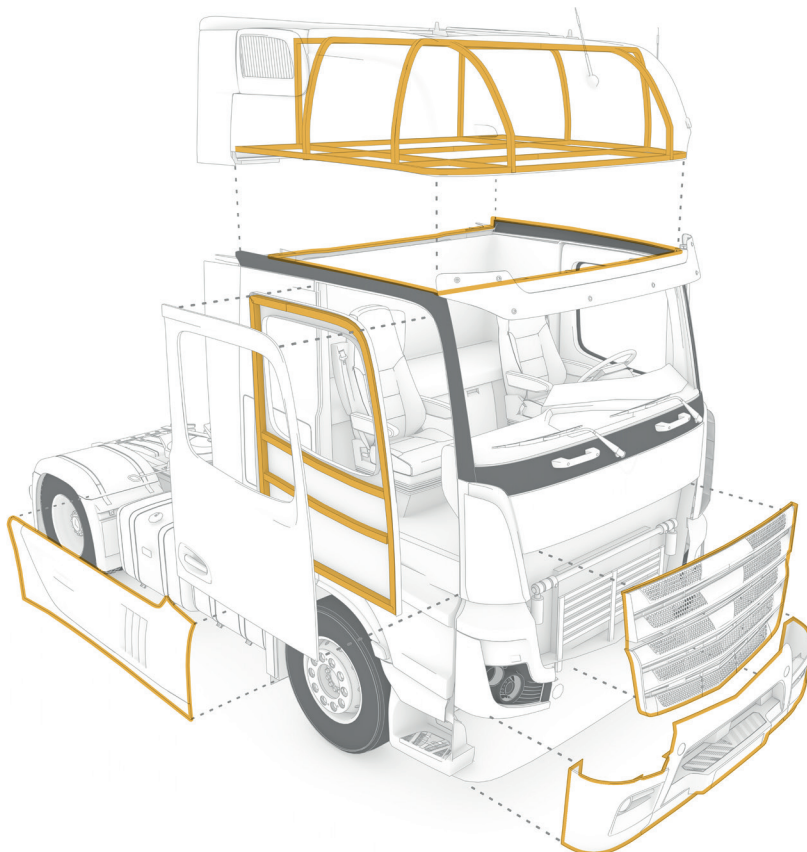

Truck end users demand maximum durability from their vehicles to overcome the day-to-day challenges on the road. Sika offers products which supports their demand.

BENEFITS

- High impact resistance combined with excellent stiffness
- Wide range of cure speeds to suit diverse customer assembly processes
- Reduced weight to improve fuel consumption
- Excellent compatibility with various composite materials
- Highly resistant to heat and aggressive climatic conditions
- Modular assembly and more freedom of design

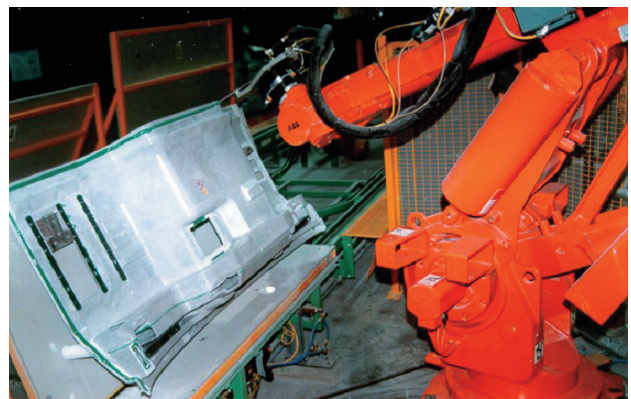

PRODUCTS	PRODUCT DESCRIPTION
Sikaflex®-254 Booster	Fast-curing assembly adhesive
Sikaflex®-554 + Sika® Hybrid Booster	Fast-curing, reduced substrate preparation
Sikaflex®-268 System	All in one adhesive/sealant system with very good ageing and weathering resistance and accelerated sealing capability
SikaPower®-1554	Multipurpose toughened thixotropic structural adhesive
SikaForce®-7xxx	Range of highly versatiled two component polyurethane adhesives
SikaFast®-5221 NT	Fast curing, two-part structural adhesive

INTERIOR TRIM

OEM's made a significant enhancement in interior comfort and functionality in recent years due to the demands from fleet operators and drivers. Performance requirements for interior components have increased, with higher operational temperature requirements, improved emissions and environmental performance needs and reduced component cost and cycle time in production.

Attractive interiors for better travel comfort require the use of different materials. Sika has developed several hot melt, solvent-based and water-based solutions to create strong adhesion to many substrates.

SikaMelt®, SikaSense® and SikaTherm® technologies are used in the lamination and bonding of a variety of interior applications including instrument panels, interior door trims, carpets, pillar trims, headliners, center consoles, stowage bins and seat assemblies.



“Aspects like operational temperature range and ecology in conjunction with lowest cost and limited cycle times were considered in Sika's development of products for the manufacturing process of interior trims.”

BENEFITS

- No visible fixings
- Broad substrate compatibility
- Fast production process
- Environmentally friendly and safe solutions
- High strength, good heat resistance
- Reduced interior noise and vibration



PRODUCTS	PRODUCT DESCRIPTION
SikaSense®-4600	Fast contact adhesive with high initial strength
SikaTherm®-4250	Multi-purpose water-based lamination adhesive
SikaMelt®-9209 HT	All-rounder PSA hot melt with high cohesion and peel strength
SikaMelt®-9289	Permanent tacky PSA hot melt for floor lamination
SikaMelt®-9600 FS	Textile lamination PUR hot melt with high final strength and flexibility
SikaMelt®-9632 SF	Reactive polyurethane hot melt adhesive

SERVICE AND SUPPORT

Sika is going beyond the supply of materials and products. A motivated team is dedicated to providing and maintaining the highest quality standards with its products and services. All Sika solutions are designed with the customers' success in mind and to establish long lasting and mutually-beneficial relationship.



TECHNICAL SERVICE AND ENGINEERING SUPPORT

Sika Industry's well-proven solutions are equally complemented with an unmatched level of support and service. The technical functions of the company are organized into dedicated local and regional teams in order to provide customers with innovative solutions, experience and knowledge. Our teams help from the idea through to the design stage and until the completion of a project with:

- Organization of project-specific material and durability tests performed by qualified laboratories
- Supplying technical documentation to support design, simulation and manufacturing processes
- Helping determine the best fit for production setups by building up similar production processes in-house
- Supporting customers independently with the evaluation and setup of equipment such as pumps and dosing units, all the way up to fully-automated cells
- Providing tailored customer application trainings

RESEARCH AND DEVELOPMENT (R&D)

With about 70 patent applications every year, Sika is one of the most innovative companies in Switzerland. 20 global technology centers are the backbone of product development. This footprint offers access to a worldwide network of partners, suppliers and scientist to guarantee customer oriented solutions.

SUSTAINABILITY IMPACT ON TRANSPORTATION BUSINESS

- Energy-saving products
- Reduced material consumption
- Considerable weight savings
- Durable and long lasting systems
- EH&S friendlier solutions

SIKA INDUSTRY BRANDS

BRAND FAMILIES	DESCRIPTION
Sikaflex®	Prepolymer-based flexible adhesives and sealants for glazing, sealing, bonding, bedding and caulking in Automotive and Industry
SikaTack®	1-component or accelerated windshield adhesives (PowerCure)
SikaForce®	1- and 2-component polyurethane adhesives range from flexible to structural strength for industrial application
Sikasil®	Silicone-based sealants and adhesives for industrial applications
SikaMelt®	Reactive and non-reactive hotmelt adhesives for industrial applications
SikaReinforcer®	2C molded epoxy expandable foam with FRP carrier for selective reinforcement in vehicle structures
Biresin®	Casting resins for models, moulds, composites, special applications
SikaBlock®	Tooling boards for model making
SikaFast®	1- and 2-component adhesive systems based on advanced acrylic chemistry
SikaLastomer®	Sealants and pre-formed tapes based on elastomeric rubbers
SikaDamp®	Butyl rubber-based products for acoustic damping
SikaPower®	1- and 2-component epoxy and epoxy-hybrid adhesives and sealants for body shop and industrial applications
SikaBaffle®	Thermoplastics or rubber-based products for acoustic insulating and sealing the vehicle cabin against noise, dust and in cavities of Automotive and Truck, granulate for moulding or co-extruded tape
SikaSense®	Water- and solvent-based 1- and 2-component adhesive systems, engineered to create an elastic, strong and durable bond on plastics, wood, synthetic, leather, cotton fibers or wood fibers
Sikagard®	Protective coatings and cavity sealers for vehicle body structures

GLOBAL BUT LOCAL PARTNERSHIP



FOR MORE TRUCK INFORMATION:



www.sika.com/truck

WE ARE SIKA

Sika is a specialty chemicals company with a leading position in the development and production of systems and products for bonding, sealing, damping, reinforcing and protecting in the building sector and the motor vehicle industry. Sika's product lines feature concrete admixtures, mortars, sealants and adhesives, structural strengthening systems, flooring as well as roofing and waterproofing systems.

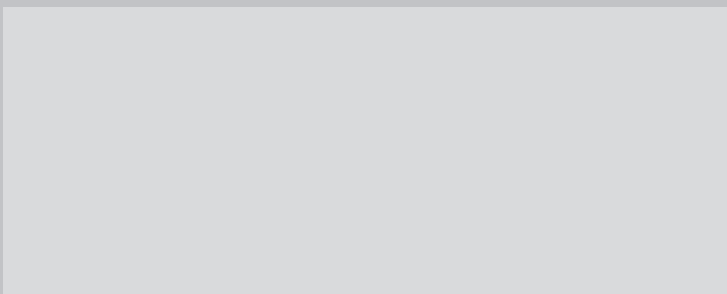

Our most current General Sales Conditions shall apply. Please consult the most current local Product Data Sheet prior to any use.



SIKA SERVICES AG
Tueffenwies 16
CH-8048 Zurich
Switzerland

Contact

Phone: +41 58 436 56 79
Fax: +41 58 436 55 30
www.sika.com/truck

BUILDING TRUST

